

## IO-Link capacitive proximity sensors

# Sensors

# CA18/30 series

## IO-Link capacitive proximity sensors

Carlo Gavazzi is proud to introduce this series of high-quality capacitive sensors to meet the demands of a new industrial era; an era that requires devices with enhanced capabilities and new ways of accessing, communicating and processing data. The Carlo Gavazzi IO-Link sensors combine their excellent features with the benefits of the IO-Link standard, which opens up the access to detailed information, advanced functionality and flexibility.

The IO-Link system provides significant advantages including enhanced data availability and workability, remote configuration and automatic parameter settings, advanced diagnostics, simplified installation and easy sensor replacement.

Get ready for the era of Industry 4.0 and the Industrial Internet of Things!

8

PREDICTIVE MAINTENANCE

1

CONFIGURABLE SENSORS

7

MULTI-FUNCTION DEVICE

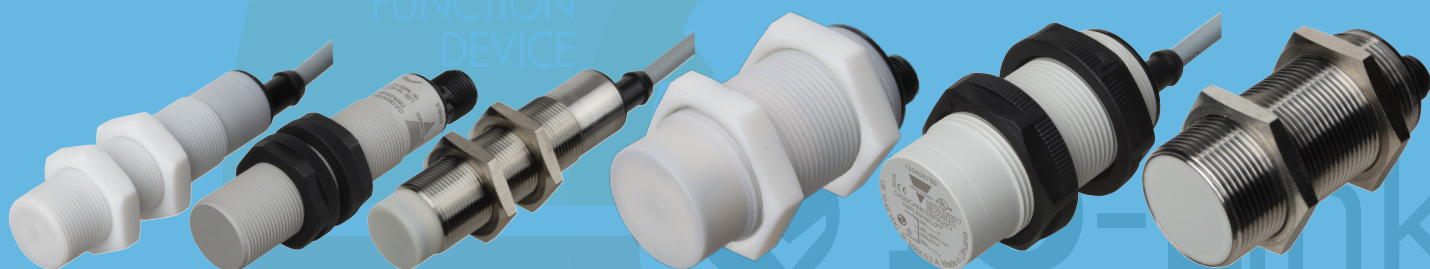

### Universal, smart and easy



#### Data availability down to the field level

Using IO-Link, the sensors can deliver their data directly into the control system very efficiently.

#### Device identification

Each IO-Link sensor has an IODD (IO Device Description), which describes the sensor, its capabilities and parameters, process data, diagnosis data and user interface configuration. Furthermore, each sensor is equipped with an internal ID.

#### Automatic parameter settings

Initial setup of a new sensor is smooth and easy using previously stored parameters. Once a sensor has been replaced, the IO-Link master simply transmits parameters stored from the old sensor.

## Universal, smart and easy

### Centralised configuration and data management

IO-Link enables fast configuration and dynamic change of the sensor parameters on the fly, which considerably reduces downtime in case of product changeover and increases flexibility and diversity of the installation.

### Simplified installation

An IO-Link system requires just standard, unshielded 3-wire cables, and a standardised uniform interface

for sensors and actuators drastically reduce the complexity of the installation process. In addition, the automated parameter reassignment simplifies sensor replacement in case of defects and prevents incorrect settings. The IO-Link-enabled sensor acts as a standard sensor when installed in a non-IO-Link system, so the same sensor can be stocked for both standard I/O (SIO) applications and IO-Link applications.

### Predictive maintenance

Advanced and detailed diagnostics

mechanisms are one of the main features of the IO-Link sensors. Moreover, the sensors continuously deliver data on their condition and are able to detect defects at an early stage or predict when a machine needs repair or replacement of spare parts. Instead of unnecessary, frequent preventive maintenance, service is need-based, and the risk of machine stoppages is significantly reduced.

## IO-Link

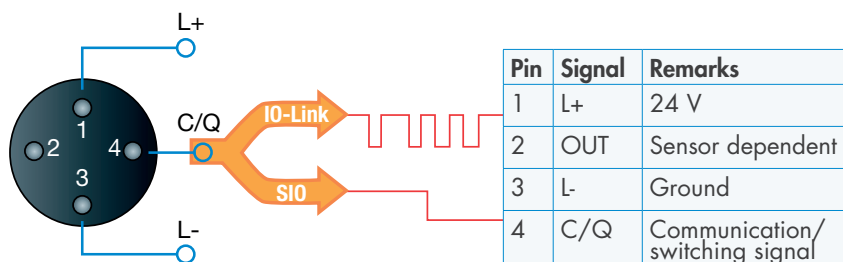
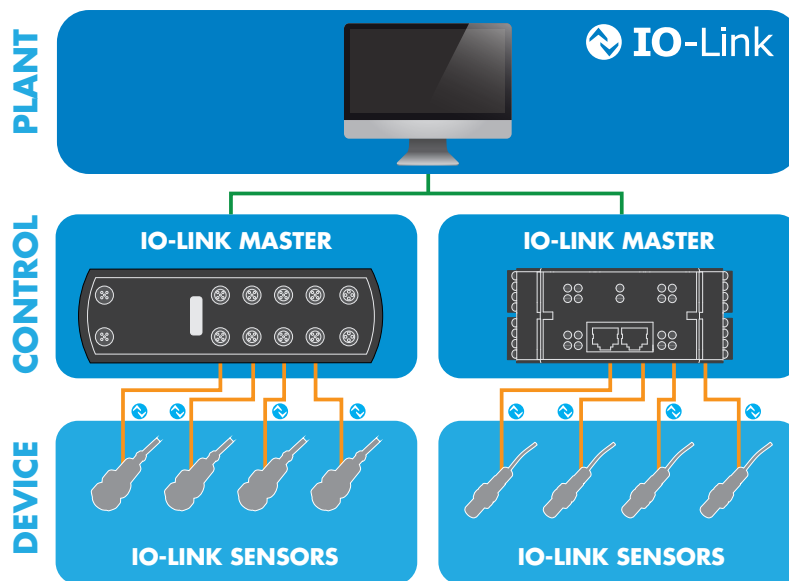

### What is IO-Link?

IO-Link is a universal, open communication standard protocol that allows IO-Link-enabled devices to exchange, collect and analyse data and convert it into actionable information.

IO-Link is recognised worldwide as an international standard (IEC 61131-9), and it is today considered as the "USB interface" for sensors and actuators in the industrial automation environment.

### Plug and play

When the IO-Link sensor is connected to an IO-Link port, the IO-Link master sends a wake-up request to the sensor, which automatically switches to IO-Link mode, and a point-to-point bidirectional communication automatically starts between the master and the sensor.

### Operating modes

The IO-Link-capable sensor can operate in two different modes; SIO mode (standard I/O) or IO-Link mode.

- SIO mode: the sensor works as a traditional sensor, and pin 4 acts as an ordinary digital output. SIO mode ensures backwards compatibility with standard sensor systems.
- IO-Link mode: exchange of data between sensor and IO-Link master takes place, and pin 4 is used for the transmission of IO-Link-related data.

# CA18/30 series

## IO-Link capacitive proximity sensors

### IO-Link functions

#### Fully configurable

IO-Link provides the first globally standardised interface for communication with the sensor. Once you have connected the sensor to the IO-Link port, you can access a multitude of configuration parameters and advanced functionalities. This way, the sensor can be tailored to meet your individual needs and requirements at a given time. The settings can also be stored in the master and can always be changed if the need occurs, or they can be smoothly transferred to a new sensor in case of sensor replacement.

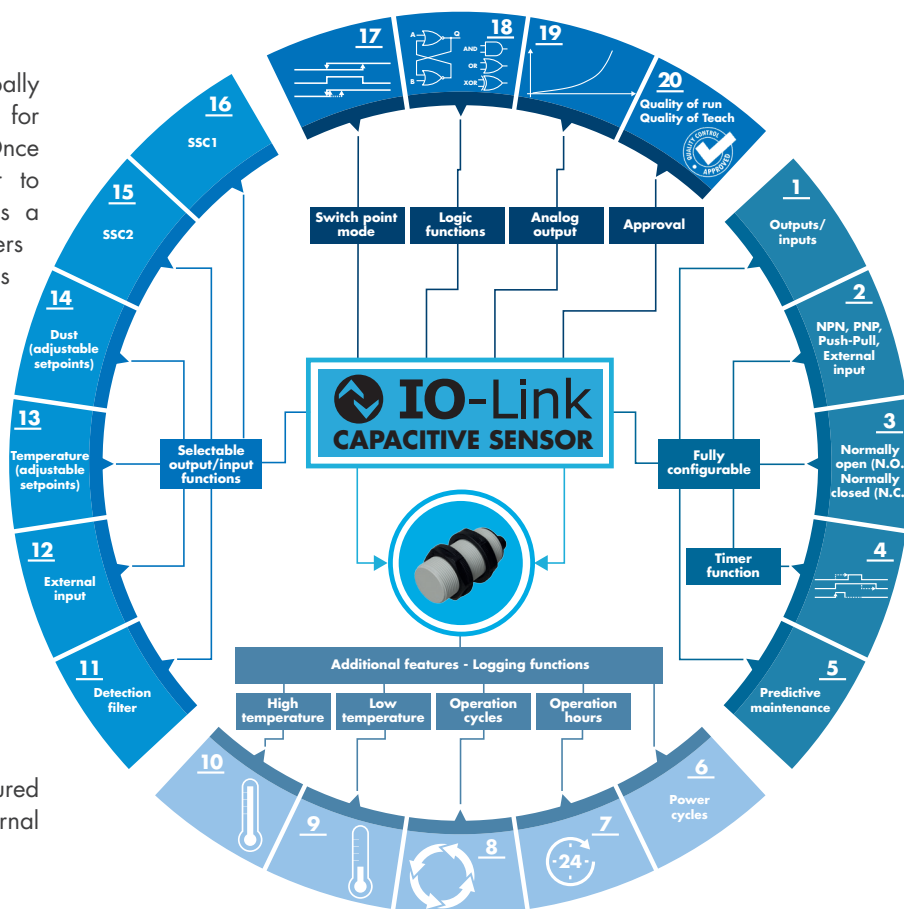

#### 1. Outputs/inputs

The sensor has two I/O terminals.

#### 2. NPN, PNP, Push-pull, External input

The I/O terminals can be configured as: NPN, PNP, push-pull or external input (only output 2).

#### 3. Normally open (N.O.) Normally closed (N.C.)

The output can be configured to normally open or normally closed.

#### 4. Timer function

It is possible to activate different timer functions: ON delay, OFF delay, ON and OFF delay or one shot (leading edge or trailing edge).

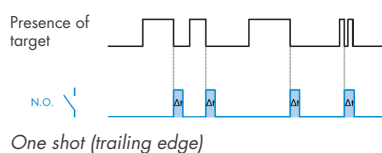
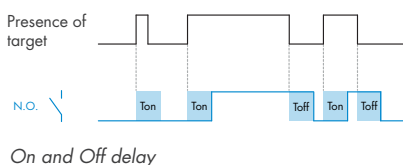
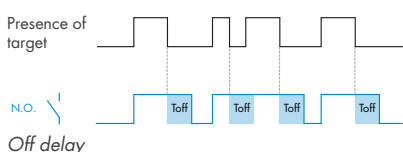
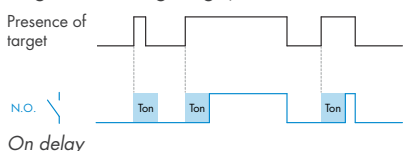

#### 5. Predictive maintenance

The sensors can provide information about their basic status during normal operation, for instance increasing contamination (dust build up). Maintenance can be required before a system fails and costly machine downtime is avoided.

#### Additional logging functions

The Carlo Gavazzi capacitive IO-Link sensors offer additional logging functions for advanced diagnostics mechanisms making both real-time and historic data available.

#### 6. Power cycles

Counts and store how many times the sensor has been powered up since its creation.

#### 7. Operation hours

Counts and store number of hours of power connected since its creation.

#### 8. Operation cycle

Number of sensor detections (SSC1) since its creation.

#### 9. Low temperature

Two different specifics are measured: The lowest temperature the sensor has been exposed to since 1. its creation (stored in sensor) 2. since last power-up.

#### 10. High temperature

Two different specifics are logged: The highest temperature the sensor has been exposed to since 1. its creation (stored in sensor) 2. since last power-up.

## IO-Link functions

### Selectable output/input functions

#### 11. Detection filter

It is a stabilising filter that increases the immunity of the variation of the sensor's measurements and media. The detection filter can be set to measure the average value of additional 1 to 255 measurements.

#### 12. External input

The external input can be controlled by outputs from sensors or PLC's.

#### 13. Temperature alarm

The sensor can be configured to give an alarm if the temperature exceeds or drops below a preset value (Tmax or Tmin).

#### 14. Dust alarm

The sensor can be configured to give an alarm if the contamination level exceeds a preset value of choice.

#### 15. SSC1

The Switching Signal Channel 1 (SSC1) output can be configured to the following four detection modes: Single-point mode, two-point mode, windows mode and adjustable hysteresis. Two individual setpoints and hysteresis can be set.

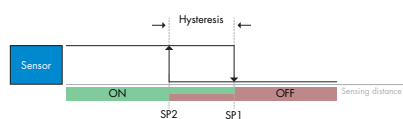
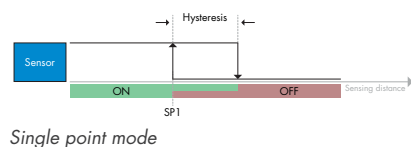

Two point mode

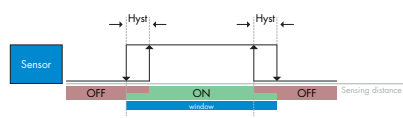

Windows mode

#### 16. SSC2

The Switching Signal Channel 2 (SSC2) output can be configured to the same modes as SSC1.

Two individual setpoints and hysteresis can be set.

### Switch point mode

#### 17. Switch point mode

SSC1 and SSC2 can be configured to single-point mode, two-point mode, windows mode, adjustable hysteresis.

### Logic functions

#### 18. Logic functions

In the logic function block the selected signals from the input selector can be added a logic function directly without using a PLC – making decentral decisions possible.

The logic functions available are: AND, OR, XOR and Gated SR-FF.

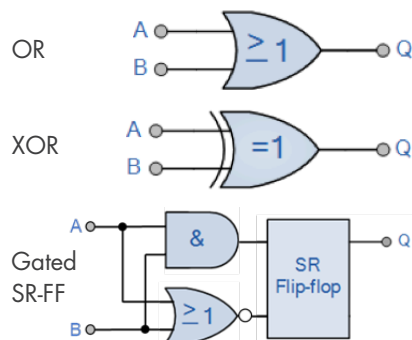
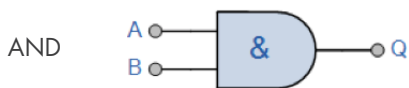

### Analogue output

#### 19. Analogue output

16 bit Analogue Output by IO-Link representing the Dielectric value measured by the sensor.

### Approval

#### 20. Quality of run

The quality of run value informs about the actual sensing performance compared to the set-points of the sensor, the higher the value the better quality of detection.



#### 20. Quality of teach

The quality of teach value informs about how well the actually teach procedure was done, meaning the margin between the actual setpoints and the environmental influence of the sensor.

## Protection

### 4<sup>th</sup> Generation TRIPLESIELD™ technology

- IP69K
- Surge ±2 kV
- Shock 30 G
- Vibration 15 G
- Rough handling shocks 1 m
- Electrostatic discharge 40 kV
- Electrical fast transients/burst ±4 kV
- Wire conducted disturbances 20 Vrms
- Power-frequency magnetic fields 600 A/m
- Radiated RF electromagnetic fields 20 V/m



**ECOLAB®**

**IP69K**

# CA18/30CA series

## IO-Link sensors in PBT housing

### Features and functions

#### CA18CAF.IO Flush



#### CA18CAN..IO Non-Flush



All versions are available as cable or M12 plug versions.

#### Back part of the sensor



#### CA30CAF.IO Flush



#### CA30CAN..IO Non-Flush



All versions are available as cable or M12 plug versions.

#### Back part of the sensor



### Interchangeable housing length

For flexibility and compatibility, the new sensors, whether flush or non-flush, share the same length.

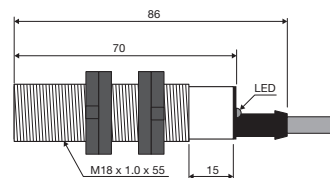

Flush

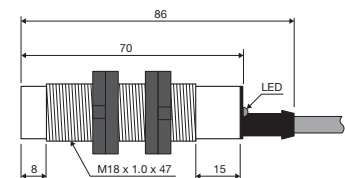

Non-flush

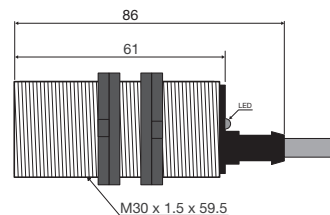

Flush

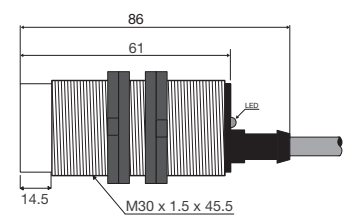

Non-flush

## The Capacitive CA18/30CA IO-Link Family

	M18 / M30 DC IO-Link 4 <sup>TH</sup> Generation TRIPLESIELD™			
	M18		M30	
Connection	Flush	Non-Flush	Flush	Non-Flush
Cable	CA18CAF08BPA2IO	CA18CAN12BPA2IO	CA30CAF16BPA2IO	CA30CAN25BPA2IO
Plug	CA18CAF08BPM1IO	CA18CAN12BPM1IO	CA30CAF16BPM1IO	CA30CAN25BPM1IO
Sensing distance	0 - 8 mm	0 - 12 mm	0 - 16 mm	0 - 25 mm
Adjustable distance	2 - 10 mm	3 - 15 mm	2 - 20 mm	4 - 30 mm
IO-Link	Transmission type: COM2 (38.4 k Baud), Revision: 1.1, SDCI standard: IEC 61131-9, Profiles: Smart sensor (Process Data Variable; Device Identification), SIO mode: Yes, Required master port type: A, Min. process cycle time [ms]: 5			
Selectable function output 1	NPN, PNP or Push-Pull			
Selectable function output 2	NPN, PNP, Push-Pull, External input or External teach			
Diagnostic	Operation hours, Power cycles, Detection cyclesmax. and min. Temperatures, Short-circuit, maintenance, No of Parameter change.			
Logic functions	AND, OR, X-OR, Gated SR-FF			
Timer functions	ON Delay, OFF delay, ON+OFF delay and One shot			
Sensitivity control	Trimmer input, Teach by wire or by IO-Link			
Rated operational voltage (U <sub>s</sub> )	10 to 40 V DC (ripple included)			
No load supply current (I <sub>o</sub> )	≤ 20 mA			
Minimum operational current (I <sub>m</sub> )	≤ 0.5 mA			
Off-State current (I <sub>o</sub> )	≤ 100 µA			
Voltage drop, digital (U <sub>d</sub> )	≤ 1.0 V DC @ 200 mA DC			
Capacitive load	100 nF @ 200 mA			
Frequency of operating cycles (f)	50 Hz			
Response time t <sub>ON</sub> or t <sub>OFF</sub>	10 ms			
Power on delay (t <sub>i</sub> )	300 ms			
Hysteresis (adjustable)	6%	15%	7%	10%
Led indications	Yellow LED steady: Output ON and signal stability. Yellow LED flashing: Output short-circuit, timer indication and teach. Green LED steady: Power ON and signal stability. Green LED flashing: IO-Link mode.			
Sensor protection	Shortcircuit (A), reverse polarity (B) and transients (C)			
Electrostatic discharge	Contact discharge: > 40 kV. Air discharge: > 40 kV (IEC 61000-4-2)			
Electrical fast transients/burst	±4kV/5kHz (IEC 61000-4-4; EN 60947-1)			
Surge	Power-supply: > 2kV (with 500 Ω). Sensor output: > 2kV (with 500 Ω) (IEC 61000-4-5)			
Wire conducted disturbances	> 20 Vrms (IEC 61000-4-6)			
Power - frequency magnetic fields	Continuous: > 60 A/m, 75.9 µ tesla. Short-time: > 600 A/m, 759 µ tesla (IEC 61000-4-8)			
Radiated RF electromagnetic fields	> 20 V/m (IEC 61000-4-3)			
Vibration	10 to 150 Hz, 1 mm/15G in X,Y and Z direction (EN 60068-2-6)			
Shock	30G /11 mS. 3 positive and 3 negative in X,Y and Z direction (EN 60068-2-27)			
Drop test	2 times from 1m, 100 times from 0,5m (EN 60068-2-31)			
Degree of protection	IP 67, IP 68, IP 69K (EN 60529; EN 60947-1; DIN 40050-9)			
NEMA type	1, 2, 4, 4X, 5, 6, 6P, 12 (NEMA 250)			
Ambient temperature	Operating: -30 to +85°C (-22 to +185°F). Storage: -40 to +85°C (-40 to +185°F)			
Max. temperature on sensing face	120°C (248°F)			
CE marking	According to EN 60947-5-2			
Approvals	cULus (UL508), ECOLAB			
Overvoltage category	III (IEC60664; EN 60947-1)			
Pollution degree	3(IEC60664/60664A; EN 60947-1)			
MTTF <sub>d</sub>	114.6 years @ 40°C (104°F)		98.3 years @ 40°C (104°F)	
Material	Body: PBT grey, 30% glass reinforced. Trimmer shaft: Nylon, blue. Backpart: Grilamid TR55, black.			
Tightening torque	≤ 2.6 Nm		≤ 7.5 Nm	
Cable	PCV, grey, 2 m, 4 x 0.34 mm <sup>2</sup> , Ø=5.2 mm, Oil proof			
Connector	M12, 4-pin			
Dimensions	Cable and Plug: M18 x 70 mm		Cable and Plug: M30 x 61 mm	
Weight incl. packaging	Cable version ≤ 150 g, Plug version ≤ 75 g		Cable version ≤ 190 g, Plug version ≤ 106 g	
Accessories, additional	Connectors: CONB14NF-...W-series. Mounting brackets: AMB18-A... and AMB18-S...		Connectors: CONB14NF-...W-series. Mounting brackets: AMB30-A... and AMB30-S...	

# CA18/30EA series

## IO-Link sensors in stainless steel housing

### Features and functions

#### CA18EAF.IO Flush



All versions are available as cable or M12 plug versions.

#### CA18EAN.IO Non-Flush



#### Back part of the sensor

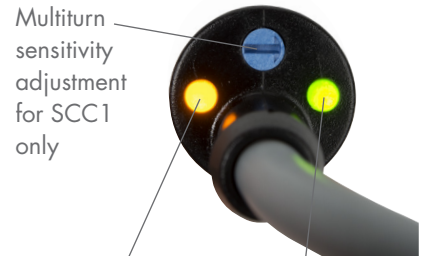

##### Yellow LED

- Output
- Short circuit
- Timer
- Find my sensor

##### Green LED

- Power
- Stability
- IO-Link communication
- Find my sensor

#### CA30EAF.IO Flush



All versions are available as cable or M12 plug versions.

#### CA30EAN.IO Non-Flush



#### Back part of the sensor



##### Yellow LED

- Output
- Short circuit
- Timer
- Find my sensor

##### Green LED

- Power
- Stability
- IO-Link communication
- Find my sensor

### Interchangeable housing length

For flexibility and compatibility, the new sensors, whether flush or non-flush, share the same length.

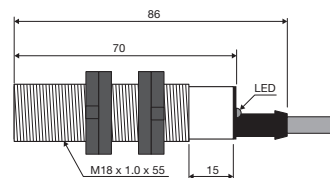

Flush

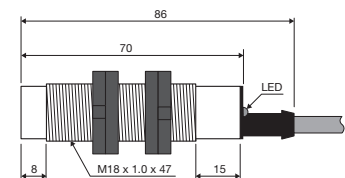

Non-flush

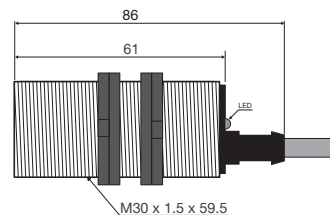

Flush

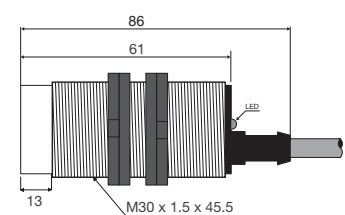

Non-flush



## The Capacitive CA18/30EA IO-Link Family

	M18 / M30 DC IO-Link 4 <sup>TH</sup> Generation TRIPLESIELD™			
	M18		M30	
Connection	Flush	Non-Flush	Flush	Non-Flush
Cable	CA18EAF08BPA2IO	CA18EAN12BPA2IO	CA30EAF16BPA2IO	CA30EAN25BPA2IO
Plug	CA18EAF08BPM1IO	CA18EAN12BPM1IO	CA30EAF16BPM1IO	CA30EAN25BPM1IO
Sensing distance	0 - 8 mm	0 - 12 mm	0 - 16 mm	0 - 25 mm
Adjustable distance	2 - 10 mm	3 - 15 mm	2 - 20 mm	4 - 30 mm
IO-Link	Transmission type: COM2 (38.4 k Baud), Revision: 1.1, SDCI standard: IEC 61131-9, Profiles: Smart sensor (Process Data Variable; Device Identification), SIO mode: Yes, Required master port type: A, Min. process cycle time [ms]: 5			
Selectable function output 1	NPN, PNP or Push-Pull			
Selectable function output 2	NPN, PNP, Push-Pull, External input or External teach			
Diagnostic	Operation hours, Power cycles, Detection cyclesmax. and min. Temperatures, Short-circuit, maintenance, No of Parameter change.			
Logic functions	AND, OR, X-OR, Gated SR-FF			
Timer functions	ON Delay, OFF delay, ON+OFF delay and One shot			
Sensitivity control	Trimmer input, Teach by wire or by IO-Link			
Rated operational voltage (U <sub>s</sub> )	10 to 40 V DC (ripple included)			
No load supply current (I <sub>s</sub> )	≤ 20 mA			
Minimum operational current (I <sub>m</sub> )	≤ 0.5 mA			
Off-State current (I <sub>s</sub> )	≤ 100 µA			
Voltage drop, digital (U <sub>d</sub> )	≤ 1.0 V DC @ 200 mA DC			
Capacitive load	100 nF @ 200 mA			
Frequency of operating cycles (f)	50 Hz			
Response time t <sub>ON</sub> or t <sub>OFF</sub>	10 ms			
Power on delay (t <sub>i</sub> )	300 ms			
Hysteresis (adjustable)	14%	15%	8%	10%
Led indications	Yellow LED steady: Output ON and signal stability. Yellow LED flashing: Output short-circuit, timer indication and teach. Green LED steady: Power ON and signal stability. Green LED flashing: IO-Link mode. Green and Yellow LEDs flashing: Find my sensor.			
Sensor protection	Shortcircuit (A), reverse polarity (B) and transients (C)			
Electrostatic discharge	Contact discharge: > 40 kV. Air discharge: > 40 kV (IEC 61000-4-2)			
Electrical fast transients/burst	±4kV/5kHz (IEC 61000-4-4; EN 60947-1)			
Surge	Power-supply: > 2kV (with 500 Ω). Sensor output: > 2kV (with 500 Ω) (IEC 61000-4-5)			
Wire conducted disturbances	> 20 Vrms (IEC 61000-4-6)			
Power - frequency magnetic fields	Continuous: > 60 A/m, 75.9 µ tesla. Short-time: > 600 A/m, 759 µ tesla (IEC 61000-4-8)			
Radiated RF electromagnetic fields	> 20 V/m (IEC 61000-4-3)			
Vibration	10 to 150 Hz, 1 mm/15G in X,Y and Z direction (EN 60068-2-6)			
Shock	30G / 11 ms. 3 positive and 3 negative in X,Y and Z direction (EN 60068-2-27)			
Drop test	2 times from 1m, 100 times from 0,5m (EN 60068-2-31)			
Degree of protection	IP 67, IP 68, IP 69K (EN 60529; EN 60947-1; DIN 40050-9)			
NEMA type	1, 2, 4, 4X, 5, 6, 6P, 12 (NEMA 250)			
Ambient temperature	Operating: -30 to +85°C (-22 to +185°F). Storage: -40 to +85°C (-40 to +185°F)			
Max. temperature on sensing face	120°C (248°F)			
CE marking	According to EN 60947-5-2			
Approvals	cULus (UL508), ECOLAB			
Overtoltage category	III (IEC60664; EN 60947-1)			
Pollution degree	3 (IEC60664/60664A; EN 60947-1)			
MTTF <sub>d</sub>	114.6 years @ 40°C (104°F)		98.3 years @ 40°C (104°F)	
Material	Body: Stainless steel AISI316L. Front: PBT white, 30% glass reinforced. Trimmer shaft: Nylon, blue. Backpart: Grilamid TR55, black.			
Tightening torque	≤ 25 Nm		≤ 30 Nm	
Cable	PCV, grey, 2 m, 4 x 0.34 mm <sup>2</sup> , Ø=5.2 mm, Oil proof			
Connector	M12, 4-pin			
Dimensions	Cable and Plug: M18 x 70 mm		Cable and Plug: M30 x 61 mm	
Weight incl. packaging	Cable version ≤ 170 g, Plug version ≤ 95 g		Cable version ≤ 250 g, Plug version ≤ 175 g	
Accessories, additional	Connectors: CONB14NF...W-series. Mounting brackets: AMB18-A... and AMB18-S...		Connectors: CONB14NF...W-series. Mounting brackets: AMB30-A... and AMB30-S...	

# CA18/30FA series

## IO-Link sensors in PTFE housing

### Features and functions

#### CA18FAF..IO Flush



#### CA18FAN..IO Non-Flush

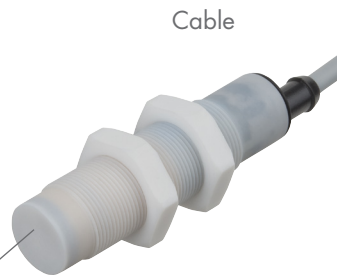

All versions are available as cable or M12 plug versions.

#### Back part of the sensor

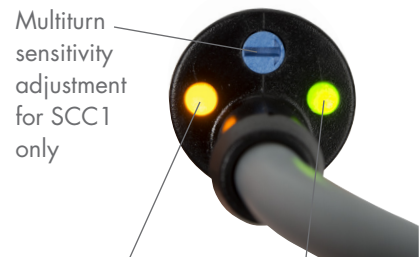

##### Yellow LED

- Output
- Short circuit
- Timer
- Find my sensor

##### Green LED

- Power
- Stability
- IO-Link communication
- Find my sensor

#### CA30FAF..IO Flush



#### CA30FAN..IO Non-Flush



All versions are available as cable or M12 plug versions.

#### Back part of the sensor



##### Yellow LED

- Output
- Short circuit
- Timer
- Find my sensor

##### Green LED

- Power
- Stability
- IO-Link communication
- Find my sensor

### Interchangeable housing length

For flexibility and compatibility, the new sensors, whether flush or non-flush, share the same length.

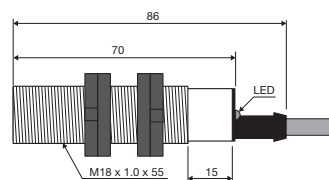

Flush

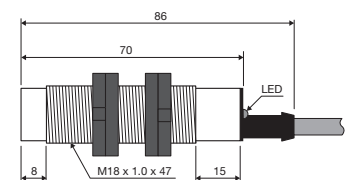

Non-flush

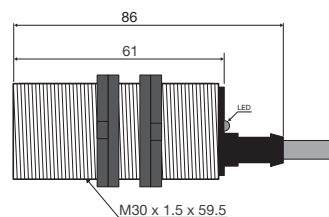

Flush

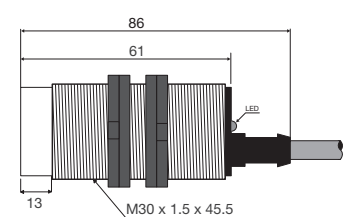

Non-flush

## The Capacitive CA18/30FA IO-Link Family

	M18 / M30 DC IO-Link 4 <sup>TH</sup> Generation TRIPLESIELD™			
	M18		M30	
Connection	Flush	Non-Flush	Flush	Non-Flush
Cable	CA18FAF08BPA2IO	CA18FAN12BPA2IO	CA30FAF16BPA2IO	CA30FAN25BPA2IO
Plug	CA18FAF08BPM1IO	CA18FAN12BPM1IO	CA30FAF16BPM1IO	CA30FAN25BPM1IO
Sensing distance	0 - 8 mm	0 - 12 mm	0 - 16 mm	0 - 25 mm
Adjustable distance	2 - 10 mm	3 - 15 mm	2 - 20 mm	4 - 30 mm
IO-Link	Transmission type: COM2 (38.4 k Baud), Revision: 1.1, SDCI standard: IEC 61131-9, Profiles: Smart sensor (Process Data Variable; Device Identification), SIO mode: Yes, Required master port type: A, Min. process cycle time [ms]: 5			
Selectable function output 1	NPN, PNP or Push-Pull			
Selectable function output 2	NPN, PNP, Push-Pull, External input or External teach			
Diagnostic	Operation hours, Power cycles, Detection cyclesmax. and min. Temperatures, Short-circuit, maintenance, No of Parameter change.			
Logic functions	AND, OR, X-OR, Gated SR-FF			
Timer functions	ON Delay, OFF delay, ON+OFF delay and One shot			
Sensitivity control	Trimmer input, Teach by wire or by IO-Link			
Rated operational voltage (U <sub>s</sub> )	10 to 40 V DC (ripple included)			
No load supply current (I <sub>s</sub> )	≤ 20 mA			
Minimum operational current (I <sub>m</sub> )	≤ 0.5 mA			
Off-State current (I <sub>o</sub> )	≤ 100 µA			
Voltage drop, digital (U <sub>d</sub> )	≤ 1.0 V DC @ 200 mA DC			
Capacitive load	100 nF @ 200 mA			
Frequency of operating cycles (f)	50 Hz			
Response time t <sub>ON</sub> or t <sub>OFF</sub>	10 ms			
Power on delay (t <sub>i</sub> )	300 ms			
Hysteresis (adjustable)	4%	15%	5%	10%
Led indications	Yellow LED steady: Output ON and signal stability. Yellow LED flashing: Output short-circuit, timer indication and teach. Green LED steady: Power ON and signal stability. Green LED flashing: IO-Link mode. Green and Yellow LEDs flashing: Find my sensor.			
Sensor protection	Shortcircuit (A), reverse polarity (B) and transients (C)			
Electrostatic discharge	Contact discharge: > 40 kV. Air discharge: > 40 kV (IEC 61000-4-2)			
Electrical fast transients/burst	±4kV/5kHz (IEC 61000-4-4; EN 60947-1)			
Surge	Power-supply: > 2kV (with 500 Ω). Sensor output: > 2kV (with 500 Ω) (IEC 61000-4-5)			
Wire conducted disturbances	> 20 Vrms (IEC 61000-4-6)			
Power - frequency magnetic fields	Continuous: > 60 A/m, 75.9 µ tesla. Short-time: > 600 A/m, 759 µ tesla (IEC 61000-4-8)			
Radiated RF electromagnetic fields	> 20 V/m (IEC 61000-4-3)			
Vibration	10 to 150 Hz, 1 mm/15G in X,Y and Z direction (EN 60068-2-6)			
Shock	30G /11 ms. 3 positive and 3 negative in X,Y and Z direction (EN 60068-2-27)			
Drop test	2 times from 1m, 100 times from 0,5m (EN 60068-2-31)			
Degree of protection	IP 67, IP 68, IP 69K (EN 60529; EN 60947-1; DIN 40050-9)			
NEMA type	1, 2, 4, 4X, 5, 6, 6P, 12 (NEMA 250)			
Ambient temperature	Operating: -30 to +85°C (-22 to +185°F). Storage: -40 to +85°C (-40 to +185°F)			
Max. temperature on sensing face	120°C (248°F)			
CE marking	According to EN 60947-5-2			
Approvals	cULus (UL508), ECOLAB			
Overvoltage category	III (IEC60664; EN 60947-1)			
Pollution degree	3(IEC60664/60664A; EN 60947-1)			
MTTF <sub>d</sub>	114.6 years @ 40°C (104°F)		98.3 years @ 40°C (104°F)	
Material	Body: PTFE. Trimmer shaft: Nylon, blue. Backpart: Grilamid TR55, black.			
Tightening torque	≤ 1 Nm		≤ 2 Nm	
Cable	PCV, grey, 2 m, 4 x 0.34 mm <sup>2</sup> , Ø=5.2 mm, Oil proof			
Connector	M12, 4-pin			
Dimensions	Cable and Plug: M18 x 70 mm		Cable and Plug: M30 x 61 mm	
Weight incl. packaging	Cable version ≤ 150 g, Plug version ≤ 75 g		Cable version ≤ 190 g, Plug version ≤ 106 g	
Accessories, additional	Connectors: CONB14NF...W-series. Mounting brackets: AMB18-A... and AMB18-S...		Connectors: CONB30A...W-series. Mounting brackets: AMB30-A... and AMB30-S...	

## OUR SALES NETWORK IN EUROPE

**AUSTRIA** - Carlo Gavazzi GmbH  
Ketzergasse 374, A-1230 Wien  
Tel: +43 1 888 4112  
Fax: +43 1 889 10 53  
office@carlogavazzi.at

**BELGIUM** - Carlo Gavazzi NV/SA  
Mechelsesteenweg 311, B-1800 Vilvoorde  
Tel: +32 2 257 4120  
Fax: +32 2 257 41 25  
sales@carlogavazzi.be

**DENMARK** - Carlo Gavazzi Handel A/S  
Over Hadstenvej 40, DK-8370 Hadsten  
Tel: +45 89 60 6100  
Fax: +45 86 98 15 30  
handel@gavazzi.dk

**FINLAND** - Carlo Gavazzi OY AB  
Ahventie 4 B, FI-02170 - Espoo  
Tel: +358 9 756 2000  
myynti@gavazzi.fi

**FRANCE** - Carlo Gavazzi Sarl  
Zac de Paris Nord II,  
69, rue de la Belle Etoile,  
F-95956 Roissy CDG Cedex  
Tel: +33 1 49 38 98 60  
Fax: +33 1 48 63 27 43  
french.team@carlogavazzi.fr

**GERMANY** - Carlo Gavazzi GmbH  
Pfnorstr. 10-14  
D-64293 Darmstadt  
Tel: +49 6151 81000  
Fax: +49 6151 81 00 40  
info@gavazzi.de

**GREAT BRITAIN** - Carlo Gavazzi UK Ltd  
4.4 Frimley Business Park,  
Frimley, Camberley, Surrey GU16 7SG  
Tel: +44 1 276 854 110  
Fax: +44 1 276 682 140  
sales@carlogavazzi.co.uk

**ITALY** - Carlo Gavazzi SpA  
Via Milano 13, I-20020 Lainate  
Tel: +39 02 931 761  
Fax: +39 02 931 763 01  
info@gavazziacbu.it

**NETHERLANDS** - Carlo Gavazzi BV  
Wijkmeerweg 23,  
NL-1948 NT Beverwijk  
Tel: +31 251 22 9345  
Fax: +31 251 22 60 55  
info@carlogavazzi.nl

**NORWAY** - Carlo Gavazzi AS  
Melkeveien 13, N-3919 Porsgrunn  
Tel: +47 35 93 0800  
Fax: +47 35 93 08 01  
post@gavazzi.no

**PORTUGAL** - Carlo Gavazzi Lda  
Rua dos Jerónimos 38-B,  
P-1400-212 Lisboa  
Tel: +351 21 361 7060  
Fax: +351 21 362 13 73  
carlogavazzi@carlogavazzi.pt

**SPAIN** - Carlo Gavazzi SA  
Avda. Iparraguirre, 80-82,  
E-48940 Leioa (Bizkaia)  
Tel: +34 94 480 4037  
Fax: +34 94 431 6081  
gavazzi@gavazzi.es

**SWEDEN** - Carlo Gavazzi AB  
V:a Kyrkogatan 1,  
S-652 24 Karlstad  
Tel: +46 54 85 1125  
Fax: +46 54 85 11 77  
info@carlogavazzi.se

**SWITZERLAND** - Carlo Gavazzi AG  
Verkauf Schweiz/Vente Suisse  
Sumpfstrasse 3,  
CH-6312 Steinhausen  
Tel: +41 41 747 4535  
Fax: +41 41 740 45 40  
info@carlogavazzi.ch

## OUR SALES NETWORK IN THE AMERICAS

**USA** - Carlo Gavazzi Inc.  
750 Hastings Lane,  
Buffalo Grove, IL 60089, USA  
Tel: +1 847 465 6100  
Fax: +1 847 465 7373  
sales@carlogavazzi.com

**CANADA** - Carlo Gavazzi Inc.  
2660 Meadowvale Boulevard,  
Mississauga, ON L5N 6M6, Canada  
Tel: +1 905 542 0979  
Fax: +1 905 542 22 48  
gavazzi@carlogavazzi.com

**MEXICO** - Carlo Gavazzi Mexico S.A. de C.V.  
Circuito Puericultores 22, Ciudad Satelite  
Naucalpan de Juarez, Edo Mex. CP 53100  
Mexico  
T +52 55 5373 7042  
F +52 55 5373 7042  
mexicosales@carlogavazzi.com

**BRAZIL** - Carlo Gavazzi Automação Ltda.  
Av. Francisco Matarazzo, 1752  
Conj 2108 - Barra Funda - São Paulo / SP  
CEP 01401-000  
Tel: +55 11 3052 0832  
Fax: +55 11 3057 1753  
info@carlogavazzi.com.br

## OUR SALES NETWORK IN ASIA AND PACIFIC

**SINGAPORE** - Carlo Gavazzi Automation  
Singapore Pte. Ltd.  
61 Tai Seng Avenue  
#05-06 UE Print Media Hub  
Singapore 534167  
Tel: +65 67 466 990  
Fax: +65 67 461 980  
info@carlogavazzi.com.sg

**MALAYSIA** - Carlo Gavazzi Automation  
(M) SDN. BHD.  
D12-06-G, Block D12,  
Pusat Perdagangan Dana 1,  
Jalan PJU 1A/46, 47301 Petaling Jaya,  
Selangor, Malaysia.  
Tel: +60 3 7842 7299  
Fax: +60 3 7842 7399  
sales@gavazzi-asia.com

**CHINA** - Carlo Gavazzi Automation  
(China) Co. Ltd.  
Unit 2308, 23/F.,  
News Building, Block 1, 1002  
Middle Shennan Zhong Road,  
Shenzhen, China  
Tel: +86 755 83699500  
Fax: +86 755 83699300  
sales@carlogavazzi.cn

**HONG KONG** - Carlo Gavazzi  
Automation  
Hong Kong Ltd.  
Unit No. 16 on 25th Floor, One  
Midtown,  
No. 11 Hoi Shing Road, Tsuen Wan,  
New Territories, Hong Kong  
Tel: +852 23041228  
Fax: +852 23443689

## OUR COMPETENCE CENTRES AND PRODUCTION SITES

**DENMARK** - Carlo Gavazzi Industri A/S  
Hadsten

**MALTA** - Carlo Gavazzi Ltd  
Zejtun

**ITALY** - Carlo Gavazzi Controls SpA  
Belluno

**LITHUANIA** - Uab Carlo Gavazzi Industri Kaunas  
Kaunas

**CHINA** - Carlo Gavazzi Automation  
(Kunshan) Co., Ltd.  
Kunshan

## HEADQUARTERS

Carlo Gavazzi Automation SpA  
Via Milano, 13 - I-20020  
Lainate (MI) - ITALY  
Tel: +39 02 931 761  
info@gavazziautomation.com



**CARLO GAVAZZI**  
Automation Components

*Energy to Components!*

www.gavazziautomation.com

